

TORC



Scan or [click](#) to see the document on Torc's website

ADS Equipped Freightliner Cascadia Emergency Response Guide

TORC Emergency Number: 1-888-747-1691



The purpose of this document is to assist first responders and safety officials who may interact with Torc trucks equipped with our Automated Driving System (ADS) on how to engage with the truck in the event of an emergency. This information will be updated on a periodic basis as required.

Physical copies of this guide may be found in both the driver-side and passenger-side door pockets.

NOTE: At this time, all vehicles have licensed, trained human drivers that will take control of the truck in any interaction with first responders.



Emergency Response Guide

ADS Equipped Freightliner Cascadia, 2024 and 2025 models

0. Rescue Sheets

1. Identification / recognition

page 3

2. Immobilization / stabilization

page 4

3. Disable direct hazards

page 7

4. Access to occupants

page 8

5. Stored energy / liquids / gases / solids

page 10

6. In Case of Fire

page 11

7. Towing / transportation

page 12

8. Important additional information

page 14

1. Identification / recognition

The Torc truck platform is a Freightliner Cascadia that has been equipped for ADS operations. The truck can be identified by the following exterior features (**Figure 1**):

- Sensors and cameras mounted to the cab on the roof, the bumper, and below the doors.
- Torc branding is present on the front hood and may be present on the doors.

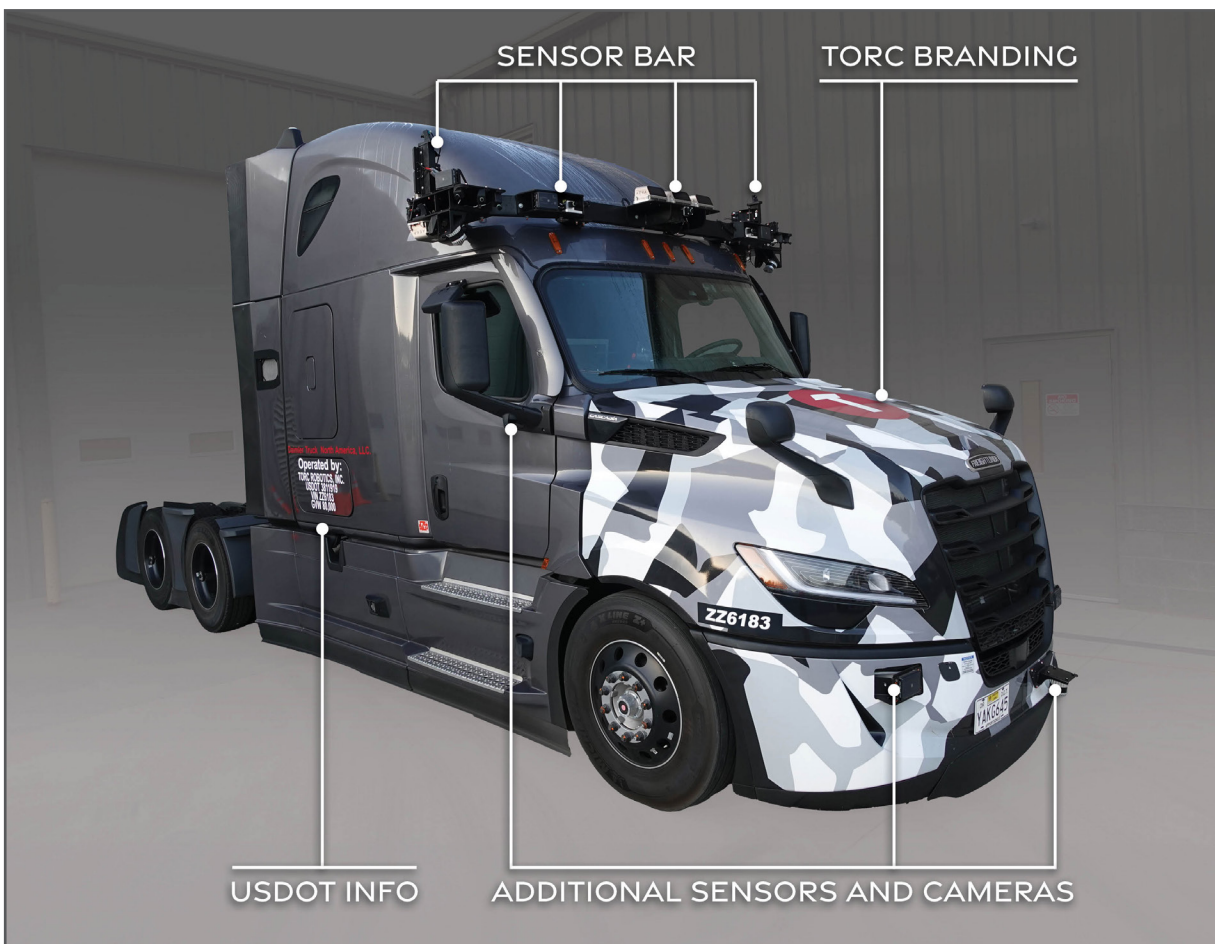

Figure 1. Torc truck

- A trailer displaying either Torc or Torc partner branding may be attached to the tractor.
- The US Department of Transportation (USDOT) number is located on both the driver- and passenger-side baggage compartment doors. It will show the following:
 - TORC Robotics, Inc. USDOT #3811919

2. Immobilization / stabilization

To ensure that the ADS is disabled and the truck is stationary, the following steps should be taken in sequence:

1. Retrieve the wheel chocks from the driver side baggage compartment (**Figure 3**) and chock the wheels. The compartment can be opened by pulling the handle (**Figure 2**) just inside the driver side door. Additionally, hazard warning devices are found here and may be deployed if necessary.



Figure 2. Driver-side baggage compartment handle



Figure 3. Driver-side baggage compartment

2. Press the yellow Emergency Manual Override (EMO) (**Figure 4**) button located on top of the dashboard to disable the ADS system. Once disabled, the status lights beneath the button will all be red.

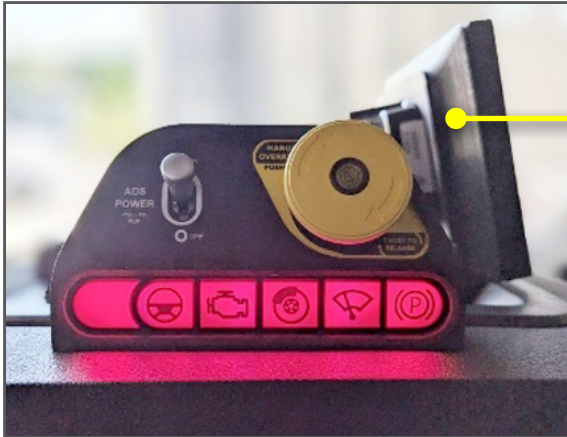

Figure 4. Emergency Manual Override (EMO)

Identifying ADS status:

The lights below the yellow EMO button indicate the ADS status.

Green: ADS driving available but not engaged

Blue: ADS driving engaged

Red: ADS driving not available



Figure 5. Dashboard view of EMO and parking brake location

3. Apply the parking brake by pulling both the red and yellow brake switches (**Figure 6**).



Figure 6. Parking brake switches

4. Turn the ignition off (**Figure 7**).

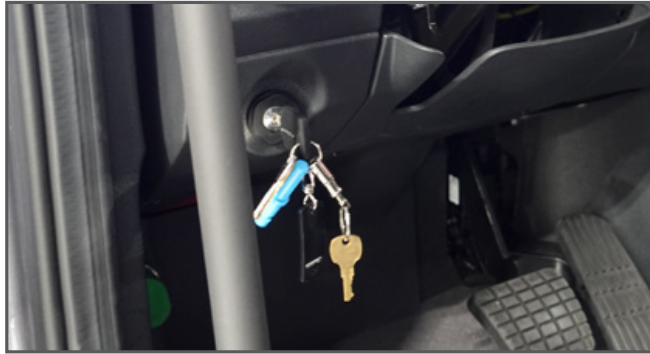

Figure 7. Ignition

5. Turn all six battery disconnects (two inside access panel below driver steps (**Figure 8**), two on either side of catwalk in rear of truck (**Figure 9**) to the “off” position (**Figure 10**).

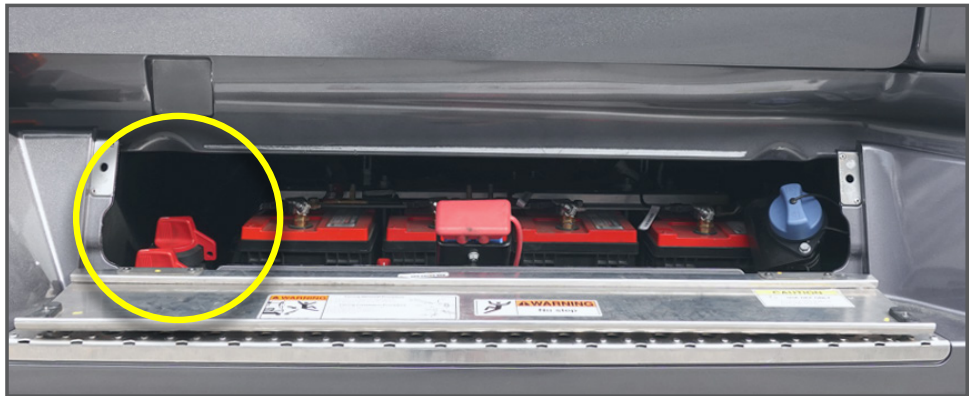

Figure 8. Driver step hatch with battery bank and disconnects

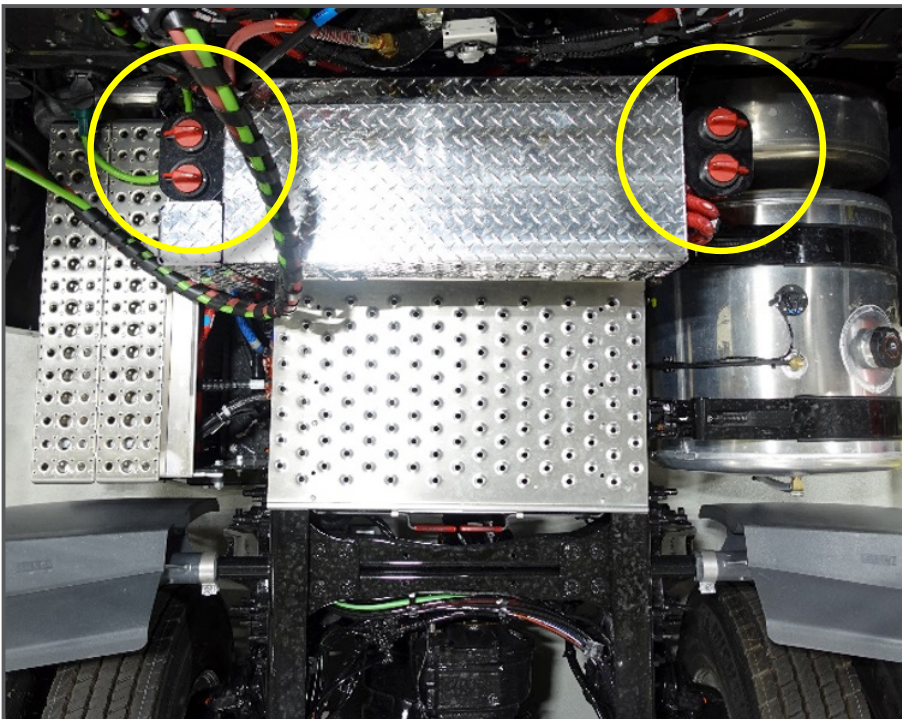

Figure 9. Birds eye view of rear battery disconnects



Figure 10. Switches in off position

3. Disable direct hazards

Figure 11. Emergency Manual Override (EMO)

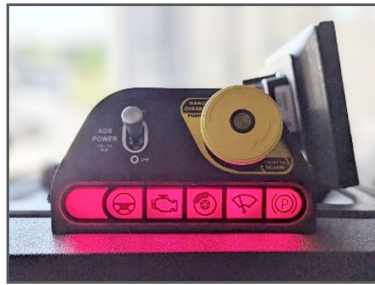

Emergency Manual Override disables ADS

Figure 12. Passenger-side battery disconnects



Red switches cut power to ADS system



Figure 13. Driver-side battery disconnects

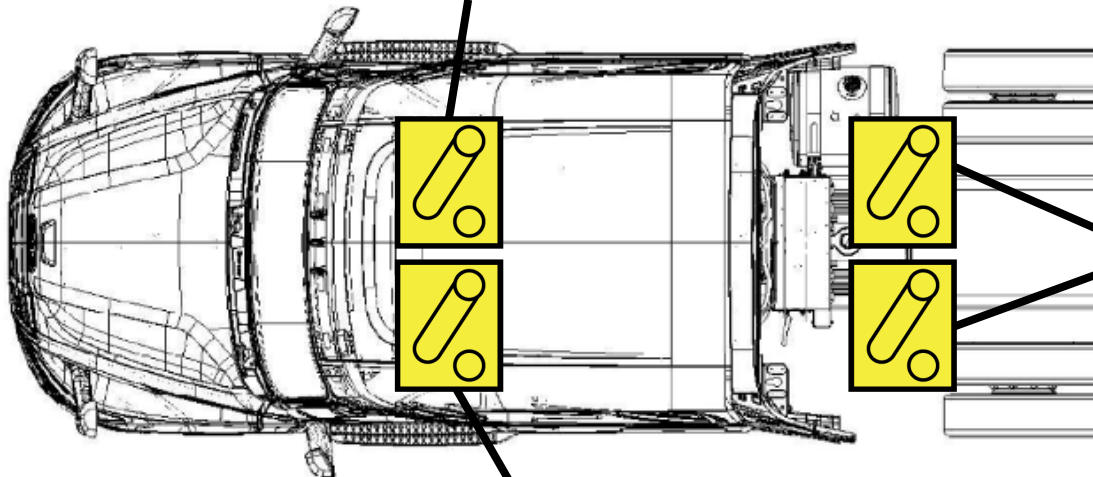

Keyed ignition turns off the engine

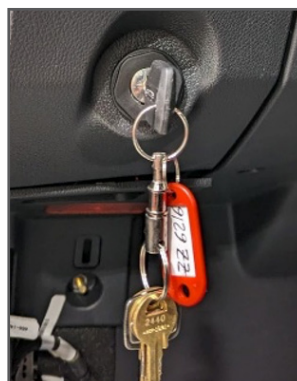

Figure 14. Ignition

4. Access to occupants

The Freightliner Cascadia truck seats a maximum of four people and has two points of entry: the driver-side door (**Figure 15**) and the passenger-side door (**Figure 16**). Operations will include a safety driver and may include up to three passengers.

To safely enter/exit the truck from either the driver or passenger side

1. Use a firm grasp on the handholds.
2. Only move one limb at a time, always maintaining three points of contact with the truck.
3. Be certain to use the correct footholds. Never use a tire or a wheel hub as a foothold. These surfaces are likely to be slippery, and there is no good traction on a rounded surface.
4. To reduce the likelihood of personal injury, do not attempt to exit the truck with your back to the cab.

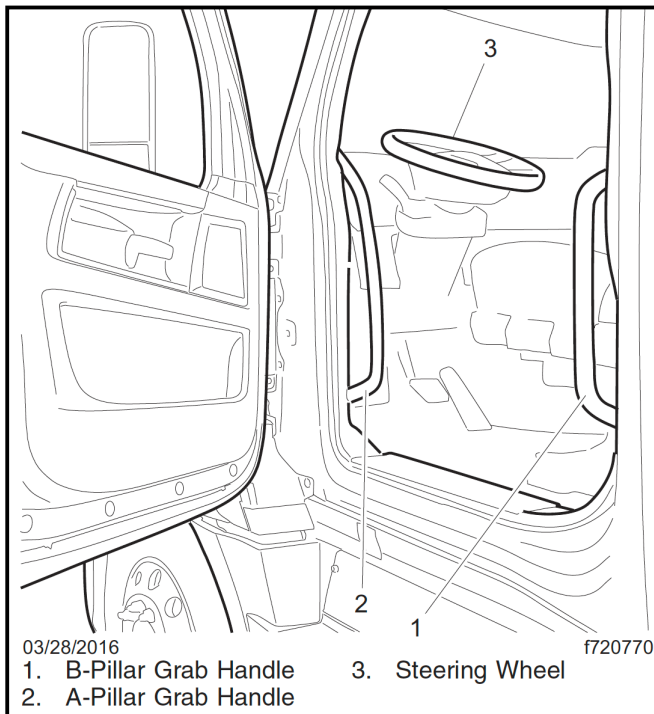

Figure 15. Driver-side entry (DTNA, 2024)

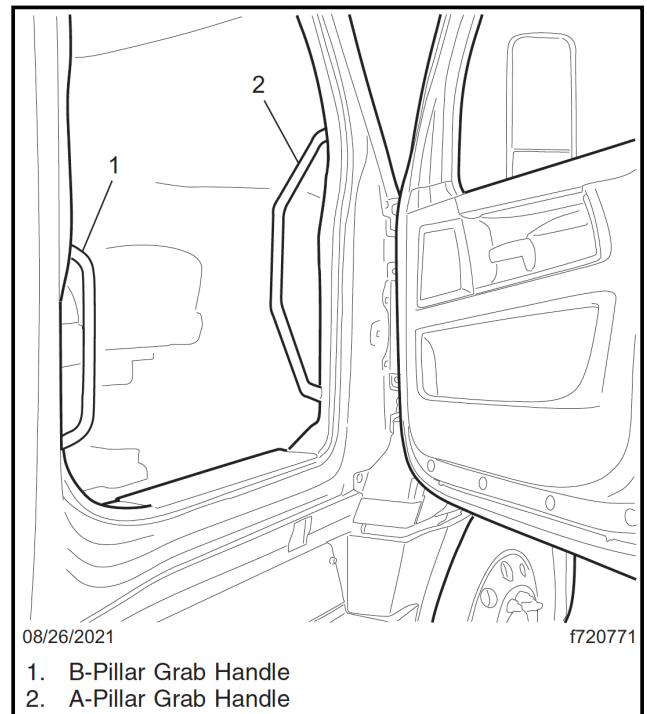

Figure 16. Passenger-side entry (DTNA, 2024)

Rear Passenger seating area

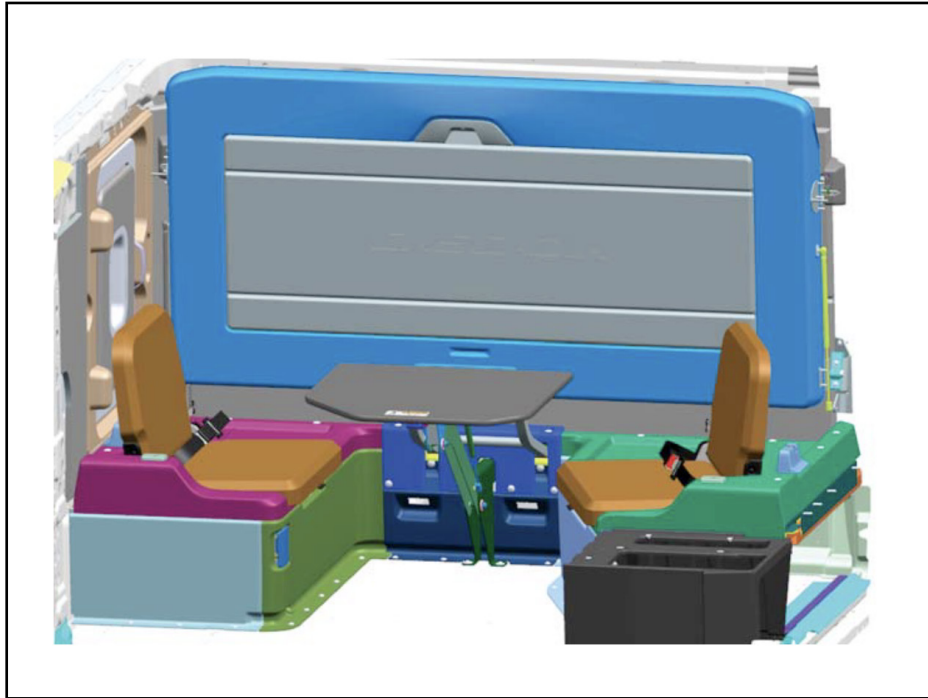

Figure 17. Rear passenger seats (modified from DTNA, 2024)

Note: DO NOT cut into the rear bulkhead of the cab (**Figure 18**) or the passenger baggage compartment; high voltage wiring, computer infrastructure, and coolant lines exist in this area.

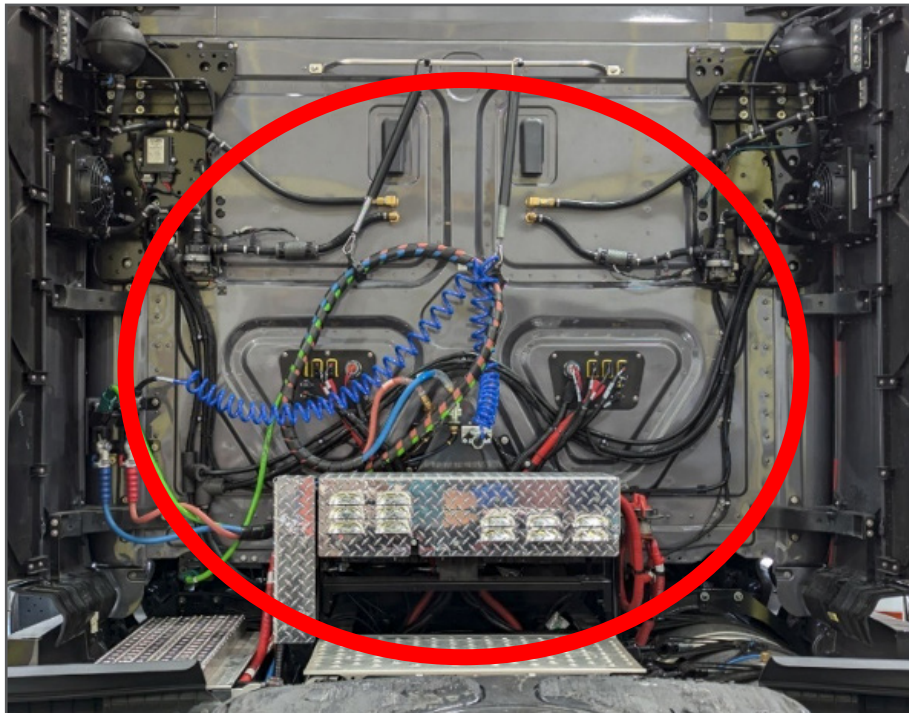
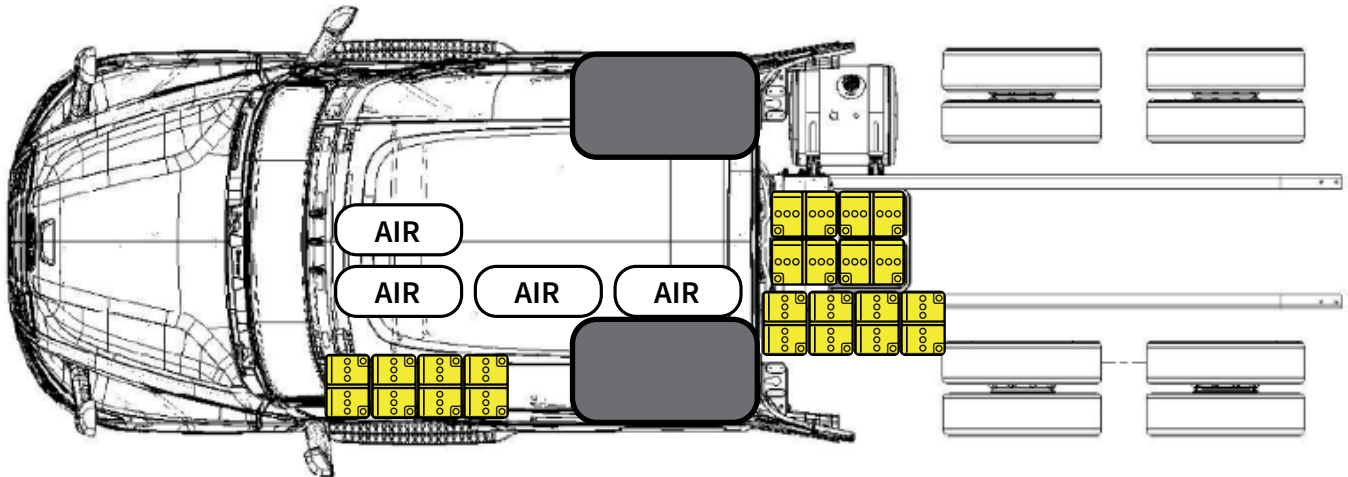

Figure 18. Rear bulkhead hazards for cutting

5. Stored energy / liquids / gases / solids



AIR

Stored compressed air



Diesel fuel tank



Battery

The Torc Autonomous Freightliner Cascadia has multiple types of stored energy, including battery banks, diesel tanks, and compressed air. Be extremely cautious around any exposed wiring, air lines, or fuel lines.

6. In Case of Fire

The Torc Autonomous Freightliner Cascadia is NOT equipped with any alternative fuel sources.

The truck is conventionally powered with diesel tanks on either side of the cab. Standard fire fighting protocols can be utilized.

A fire extinguisher can be found inside the cab mounted directly behind the driver-side seat as seen below (**Figure 19**).



Figure 19. Fire extinguisher

7. Towing / transportation

Before removing the truck from the roadway, it is important to ensure that the ADS is fully disabled according to Section 2, Immobilization / Stabilization.

NOTE: There are no ADS features to consider when detaching a trailer from the tractor; all ADS hardware is located on the tractor.

If the truck is drivable, a qualified Torc driver should move it. If a driver is unavailable and the truck is not impeding traffic, contact Torc's First Response team at 1-888-747-1691 to dispatch a driver as soon as possible. If the truck is impeding traffic and a driver is unavailable, or the truck is not drivable, the truck must be recovered and/or towed.



Figure 20. Recovery hook location

Before moving the truck, disable the ADS according to Section 2, Immobilization / Stabilization.

Recovery Hooks

Remove the recovery hooks, which are located under the hood, behind the driver-side bumper (**Figure 20**).



Figure 21. Recovery hook attachment locations

There may be knock out covers over the attachment locations (**Figure 21**) that will need to be removed prior to attaching the recovery hooks.

NOTICE

When using recovery hooks to move the truck, **do not** pass a sling (for example, a rope or chain) from one hook to another. Known as reeving, this practice is not permissible in most industrial applications of towing and hoisting. Reeving can overload the hooks and result in damage to the truck. (DTNA, 2024)

NOTE: Recovery hooks are to be used for recovery only, not towing.

The truck should be towed with a heavy-duty wrecker, and upon removal from the scene a lowboy trailer may be used if longer distance transport is required.



Emergency Response Guide

ADS Equipped Freightliner Cascadia, 2024 and 2025 models

8. Important additional information

Torc is an independent subsidiary of Daimler Truck AG. We are developing ADS-equipped trucks that will operate without human intervention in defined domains and conditions. Our initial product offering is long haul, middle-mile operation. The truck is equipped with sensors for perceiving the environment, and automated controls for steering, braking, and throttle, which allow the truck to navigate the roadways autonomously.

Our tests are conducted using a systematic test progression plan and an operating design domain (ODD) that defines the operating conditions appropriate for testing. The conditions and locations where we conduct testing will expand incrementally over time following our rigorous, systematic development process that includes the use of computer simulation and closed course testing. Torc's trucks currently operate on a variety of roadways, including highways, ramps, and surface streets. Torc's trucks may operate in either daytime or nighttime conditions.

A crew is present at all times to maintain safe operation of the truck. Safety drivers sit in the driver's seat to supervise the truck's performance and drive the truck manually when needed. When the ADS is engaged, the driver monitors the operation and is prepared to take control of the truck. Other crew members may be present to assist with truck operations.

Other Resources

Automated Vehicle Safety Consortium. (2020). Best Practice for First Responder Interactions with Fleet-Managed Automated Driving System-Dedicated Vehicles (ADS-DVs). SAE Industry Technologies Consortium.

Daimler Truck North America LLC. (2024, May 3). Freightliner Cascadia Driver's Manual. Retrieved November 4, 2024, from freightliner.com: [https://www.dtnatechlit.com/portal-public/0000113192-new-cascadia-drivers-manual/0000113192.xml/\\$/0000087562](https://www.dtnatechlit.com/portal-public/0000113192-new-cascadia-drivers-manual/0000113192.xml/$/0000087562)

For more information visit torc.ai.

**In the event of an emergency, first responders can call
Torc's First Response Team at 1-888-747-1691**